

# SURGE PROTECTIVE DEVICES

## TECHNICAL GUIDE

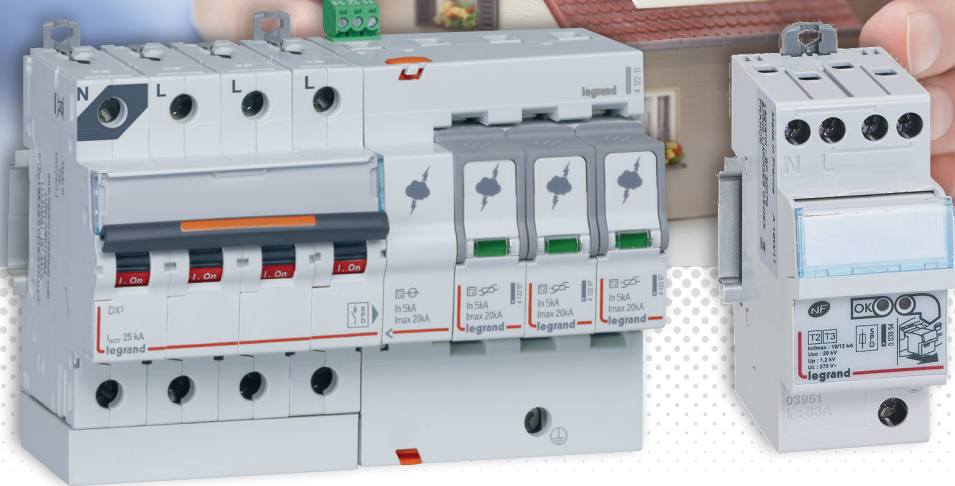

Depending on the frequency and intensity (type and area), storm phenomena cause lightning strikes to Earth.

These strikes cause either physical damage to installations or damage to electrical equipment due to the overvoltages generated.

The protection of buildings can be managed by an “external” protection system, allowing the lightning to be captured: the lightning rod.

Electrical equipment can be protected against overvoltages by using surge protective devices, also known as SPDs.

Legrand’s range of surge protective devices provides solutions suitable for all types of installation and all levels of risk.

This technical guide provides a better understanding of SPDs and how to select and install them.

Particular attention must be paid to illustrations that do not include personal protective equipment (PPE). PPE are legal and regulatory obligations.

In accordance with its policy of continual improvement, Legrand reserves the right to modify specifications and drawings without prior notice. All the illustrations, descriptions and technical data contained in this documentation are supplied for information purposes only and cannot be deemed as binding on the Company.

# TABLE OF CONTENTS

HOW IS LIGHTNING MADE? .....	2
What are the effects of lightning?.....	2
1. Direct lightning strikes on a building or a structure .....	2
2. Indirect lightning strikes.....	2
Where do thunderstorms occur?.....	5
UNDERSTANDING SPDs.....	6
How they work .....	8
The main technologies .....	9
Surge protective device types .....	10
Why is protection needed? .....	11
SPDs and earth leakage protection .....	13
HOW TO SELECT YOUR SPDs .....	14
Understanding the standards.....	14
Selection method explained .....	16
Selecting your SPD and its associated protection .....	18
HOW TO INSTALL YOUR SPDs .....	20
In a plastic cabinet .....	21
In a metal cabinet.....	22
Impact of the length of the wires.....	23
Voltage protection level .....	24
Glossary .....	25

# HOW IS LIGHTNING MADE?

Lightning is an electrical discharge that has accumulated in clouds towards the Earth or other clouds.

Inside the cloud, violent updraughts and downdraughts cause collisions between water molecules, creating positive charges that accumulate at the top of the cloud and negative charges that accumulate at the base of the cloud ❶.

The separation of charges in the storm cloud generates an intense electric field in the space between the cloud and the ground. This will result in electrical arcs: lightning, thunderbolts ❷.

❶ Updraughts and downdraughts cause water molecules to collide

❷ Negatively-charged particles concentrated at the base of the cloud try to get back to Earth, which results in lightning

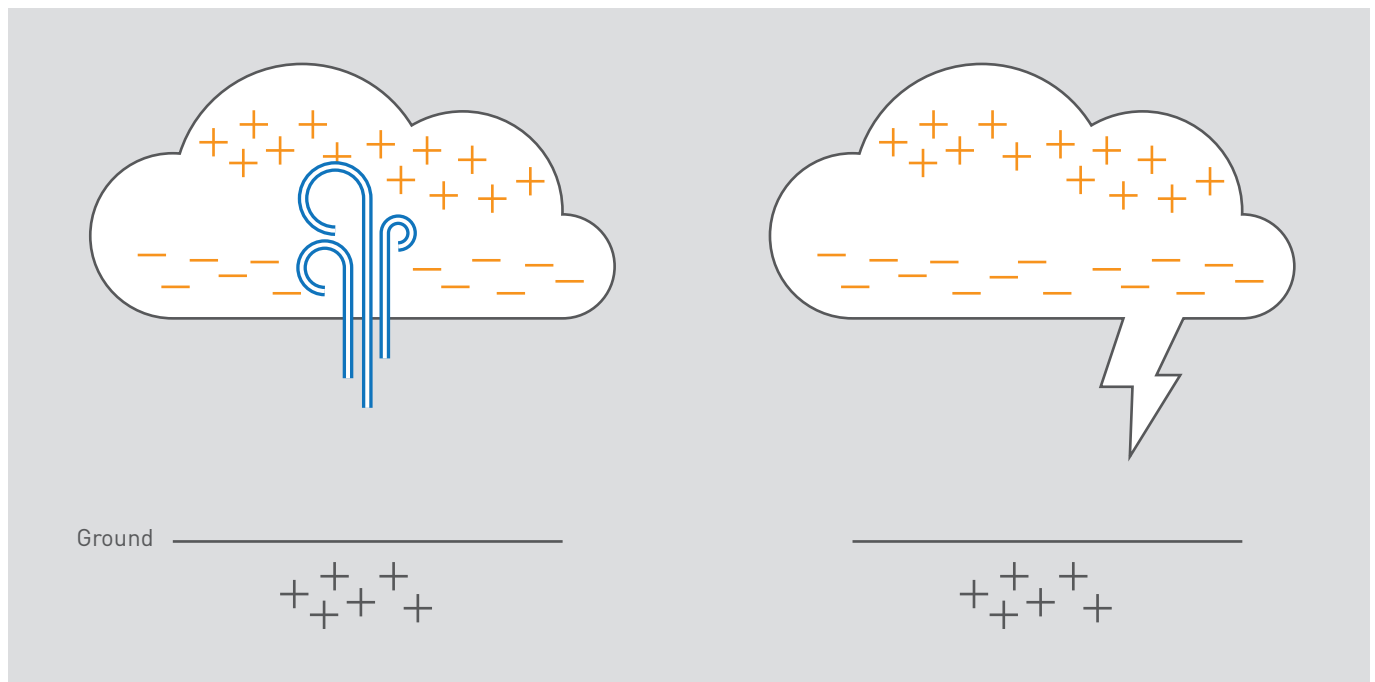

# What are the effects of lightning?

## 1 DIRECT LIGHTNING STRIKES ON A BUILDING OR A STRUCTURE

Lightning strikes the building directly and generates a very high intensity lightning current, usually between 50 and 100 kA, but sometimes up to 200 kA, flowing towards the Earth through more or less conductive elements. These elements can be the chimney, the roof, the walls, etc.



The impact of lightning can lead to the following effects:

- direct thermal (fusion, fire) due to electric arc causing physical damage
- deflagration (shock wave and blast) produced by heat and air expansion.

Protecting a building against the direct effects of lightning depends on the ability to capture and run off the lightning current to Earth. It is an external lightning protection system commonly called a lightning conductor or lightning rod.

## 2 INDIRECT EFFECTS

Indirect effects are more common: a lightning strike can remotely generate surges in an electrical network up to the inside of the building. Thus, lightning surges can damage electrical equipment.

Indirect effects can occur through:

### ■ Conduction:

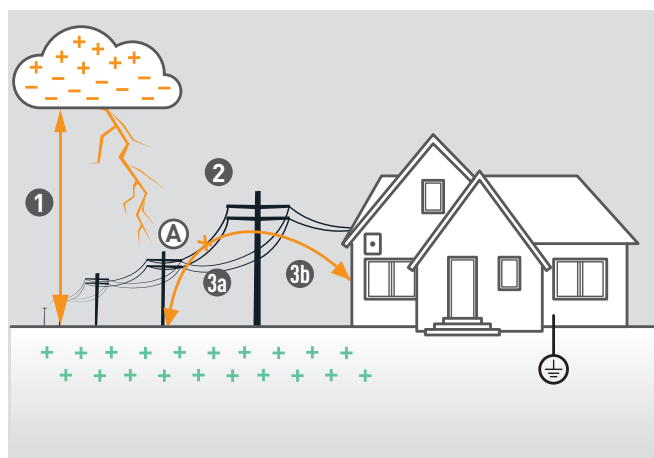

The lightning strikes a high-voltage (HV) or low-voltage (LV) overhead line. This leads to an overvoltage of several thousand volts. The steps in a lightning process are likely to unfold as follows in this case:

- 1 High voltage difference between the cloud and the earth (tens of kV)
- 2 The negative charges in the cloud seek to reach earth and materialise in the form of lightning. The overhead line becomes the strike point.
- 3 The lightning current seeks to reach the Earth, either via the network poles or transformers (3a), or via the building's electrical installation (3b).

# HOW IS LIGHTNING MADE?

## ■ Feedback from Earth:

Lightning strikes the ground, generating a voltage surge on the earth network which spreads to the installation by rising up from the ground.

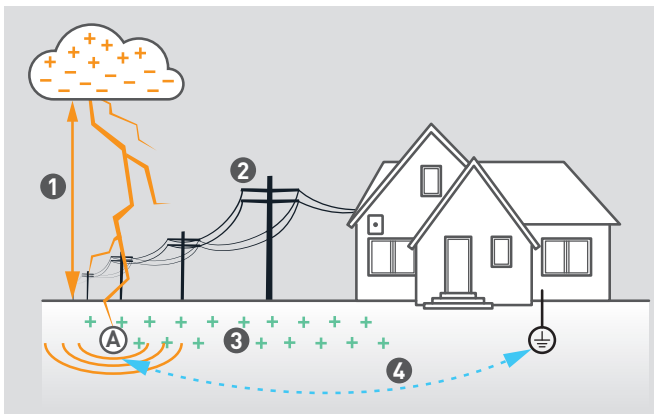

In this case, the overvoltage appears at all ground points of the installation and can damage any equipment with an earth pin (Class I Equipment):

- 1 High voltage difference between cloud and Earth (tens of kV).
- 2 The lightning bolt seeks to reach the Earth, the lightning current is in the form of an electric arc, and reaches the ground or a physical element (pole, tree, etc.) at a point (A).
- 3 The current diffuses into the ground but since its impedance is not zero, the lightning current flow then generates an increase in potential at impact point (A) (several tens of kV).
- 4 Depending on the distance between point (A) and the building's earth connection, an overvoltage may occur between the earth connection and the Phase and Neutral (230 V) power cables.

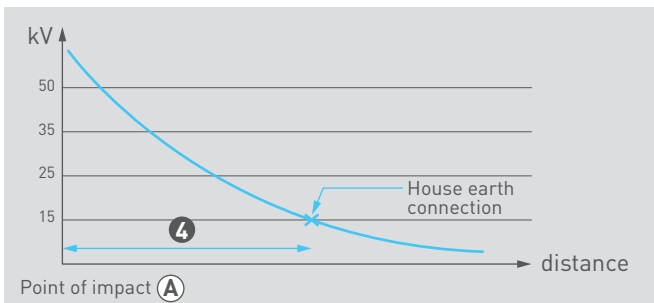

**i** Impedance is the ratio between the difference in potential at the terminals of a circuit and the current flowing through it. It is expressed in Ohm.

## ■ "Loop effect" induction:

When lightning strikes the ground, it creates electromagnetic radiation which, by coupling with the loops in the installation, can cause overvoltages of up to several kV.

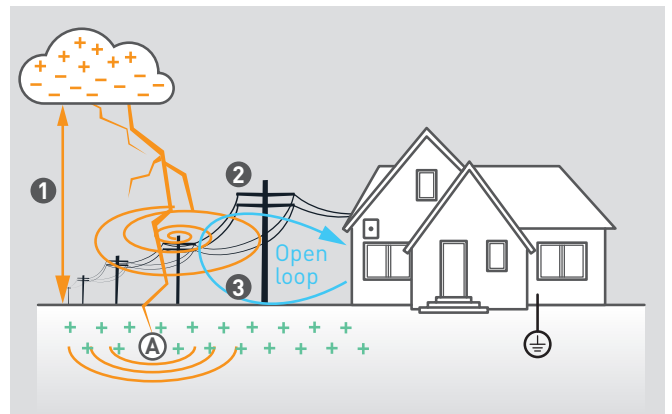

The lightning process can be broken down as follows:

- 1 High voltage difference between cloud and Earth (tens of Volts).
- 2 A lightning bolt seeks to reach the Earth, in the form of an electric arc, and reaches the ground or a physical element (tree, etc.) at a point (A).
- 3 A magnetic field forms around the lightning. An open loop, formed by the overhead power cables and the Earth, will interact with the variation in this field by generating an overvoltage at its extreme points.

**i** Damage to electrical installations is mainly due to the indirect effects of lightning strikes.

## EXAMPLES OF THE EFFECTS OF LIGHTNING ON ELECTRICAL INSTALLATIONS

- The ducts and all the insulating elements in the electrical installation age prematurely.
- Motors, coils, transformers can lose their insulation due to the breakdown effect.
- Commonly used household and domestic appliances can be damaged.
- Electronic equipment (PCs, TV, Hi-Fi systems, heating programmers, etc.) can be destroyed by damage to their internal components.
- Computer systems, fire and intruder alarms, signalling equipment can be disrupted.

# Where do thunderstorms occur?

Storm activity is an important key to determining the usefulness of a lightning conductor (external protection), but also the usefulness of the SPD. There are 2 types of data: the keraunic level (Nk) and the lightning density (Ng or Nsg).

The keraunic level (Nk) corresponds to the number of days per year when thunder is heard in a defined area. Existing maps with this feature no longer benefit from updates.

The lightning strike density (Ng, now known as Nsg since publication of the EN 62858 standard) is a more recent and measurable characteristic. It corresponds to the number of ground lightning contact points per km<sup>2</sup> and per year.

The installation standard NF C 15-100 refers to a map of keraunic levels (Nk) which distinguishes between 2 zones, AQ1 and AQ2.

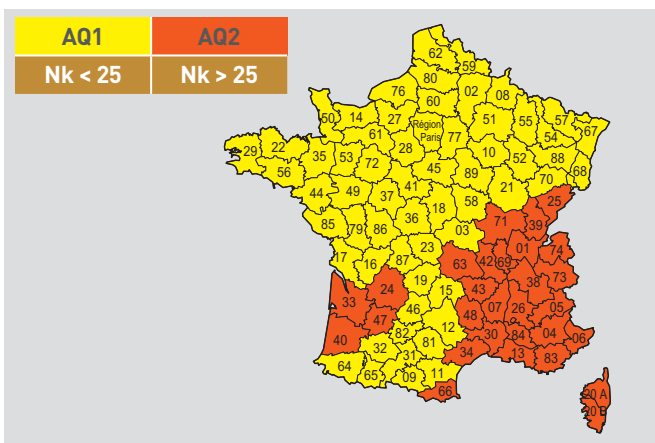

Depending on which area is concerned, and depending on the type of installation, lightning protection may be mandatory (see page 14).

The keraunic level can also be used in the case of a more comprehensive risk analysis, described in UTE Guide C15-443, to check whether it is mandatory or not.

As an indication, the map below shows the average Nsg of the French departments between 2009 and 2018.

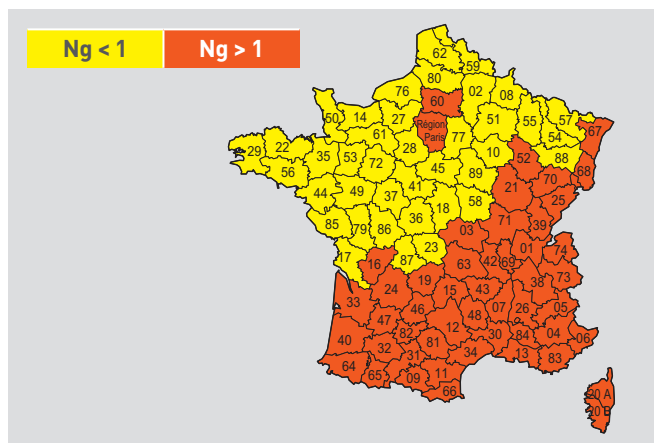

For an official, accurate and up-to-date analysis, Météorage provides a dynamic online map, because the level of lightning strikes can vary greatly within a particular department.

The map below shows the average Nk across the entire globe.

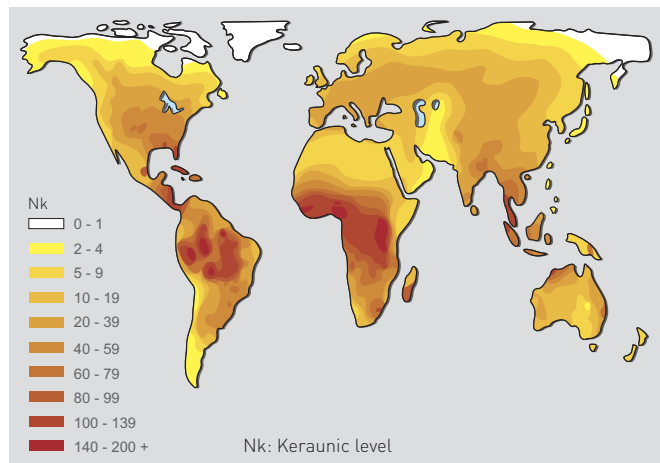

For each country, the Nk or Ng characteristics may or may not be available, and sometimes a fee may be payable.

On the other hand, depending on the extent, topology and location, a single level of average storm activity may be sufficient for a single country, but sometimes there are 3 levels.

The method presented on pages 16 to 19 uses two levels (Nk < and Nk > 25, but it can also be Nsg < 1 and Nsg > 1).

# UNDERSTANDING SURGE PROTECTIVE DEVICES

The main role of the surge protective device is to limit an overvoltage to an “acceptable” overvoltage between active poles (Phase/Neutral) and Earth, or between the phase poles and neutral, by transforming a large part of this overvoltage into a current to earth or to the grid.

The overvoltage reaches the equipment in two modes:

- 1 Via the power cables: an induced or direct overvoltage appears on the distribution network.
- 2 Due to build-up of Earth potential.

## ■ Overvoltages in the electrical installation (TT earthing system diagram)

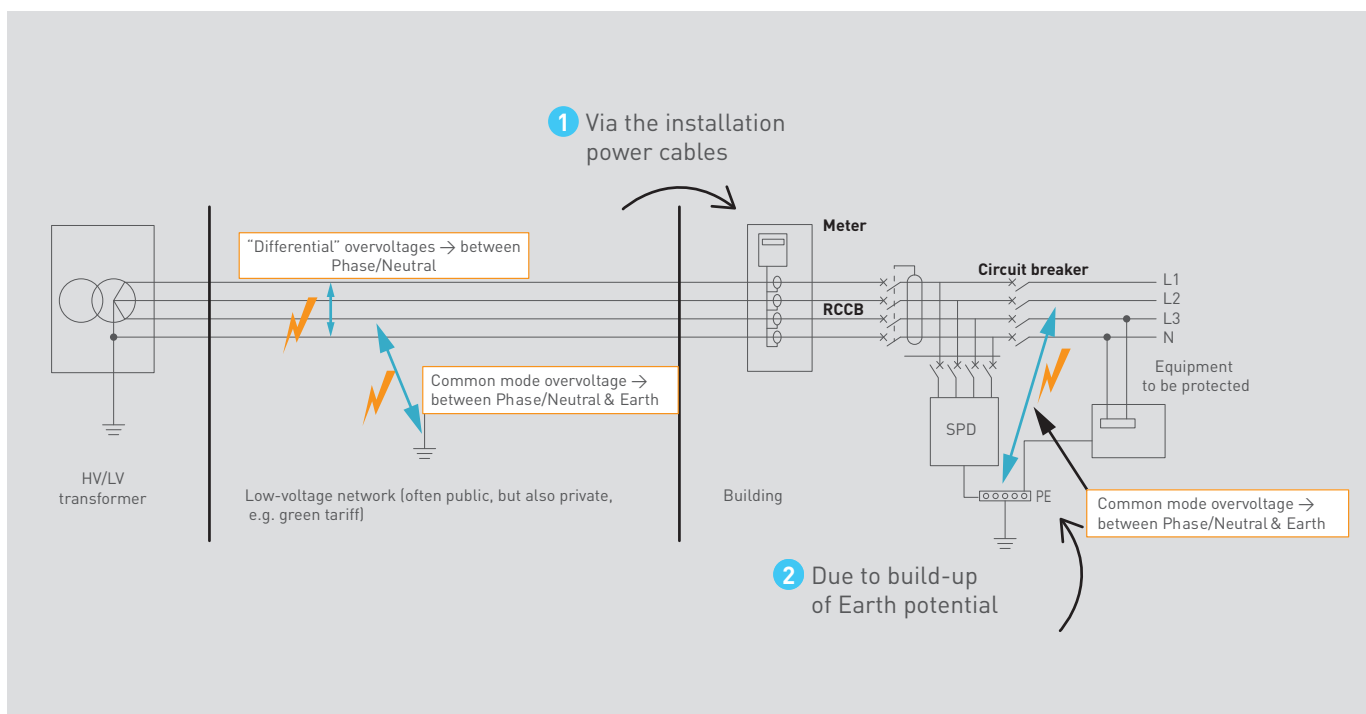



### ■ Overvoltages at normal grid voltage

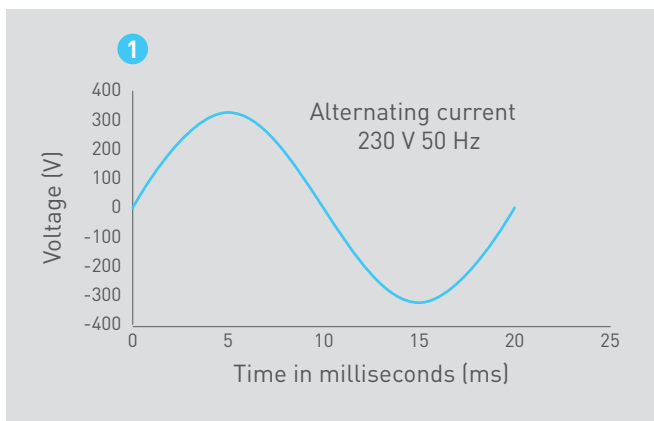

1 “Normal” voltage wave of the alternating network (example here at 230 V between Phase and Neutral)

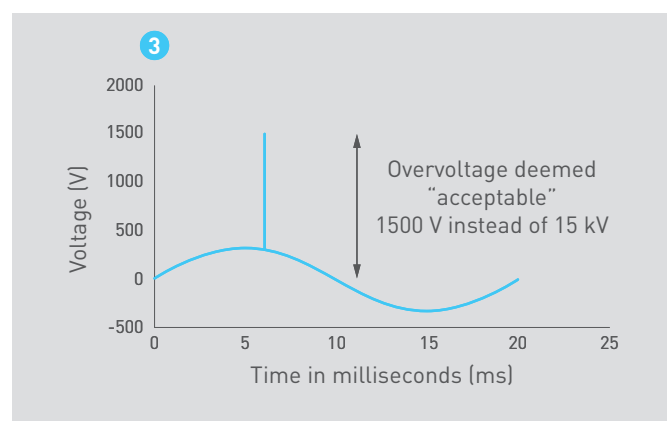

3 The surge protective device limits this overvoltage to an “acceptable” overvoltage. The trigger speed is ultra-fast (a few nanoseconds) thanks to its integrated components.

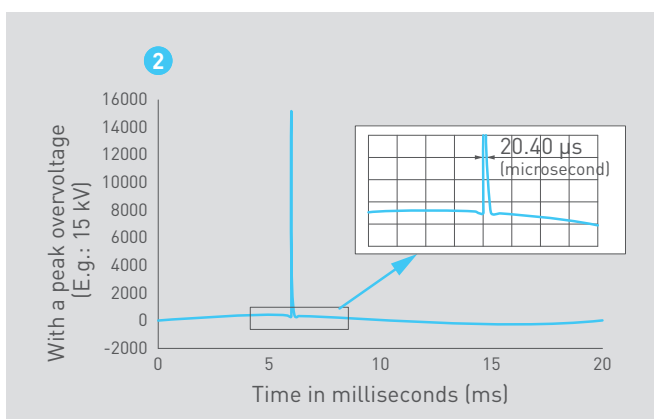

2 An indirect overvoltage of the lightning type is superimposed on the grid voltage. Graph 2 shows the very short time scale (a few microseconds) of the overvoltage. It also highlights the high voltage amplitude.

## How they work

The role of the surge protective device is therefore to limit overvoltages, by discharging this destructive energy to Earth. In the event of a build-up of Earth potential, the energy is dissipated to the grid. The SPD acts as a switch that can only close during an overvoltage. For example, between the active poles and the Earth over the short overvoltage period, the impedance becomes very low and results in a high discharge current according to Ohm's simple law: overvoltage  $U = I \times Z$  impedance. This is why surge protective devices have flow capacities often expressed in kA. SPDs are then installed at the supply end of the installation between the active poles of the power circuit and the Earth.

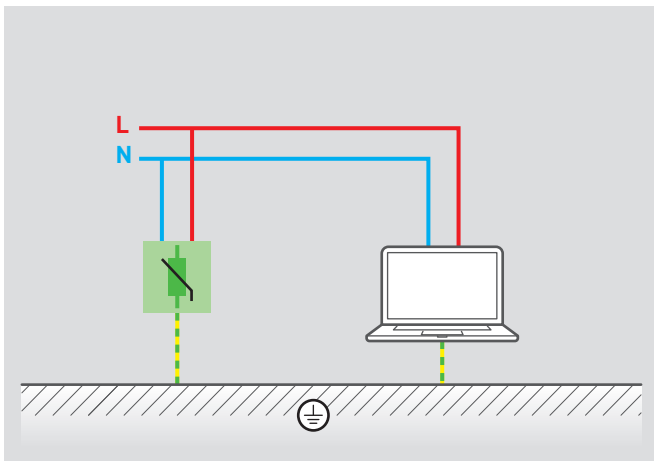

When the voltage is normal, the surge protective device does not let any current pass through.

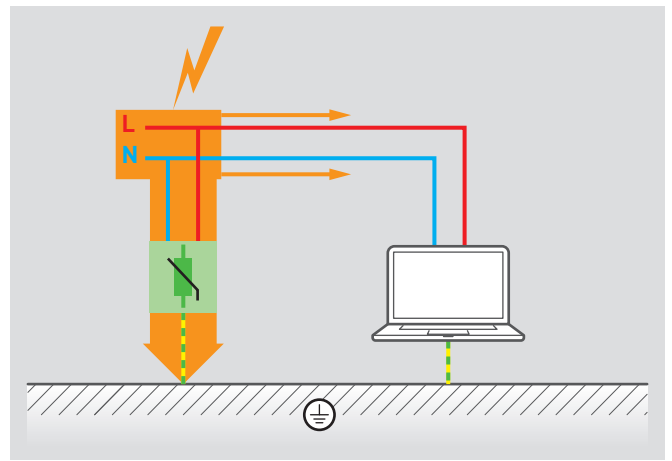

A lightning strike causes an overvoltage, most of the time between the line and the Earth: the SPD then becomes a conductor and allows this energy to flow, which limits the overvoltage.

### ■ Operation of the SPD in three steps

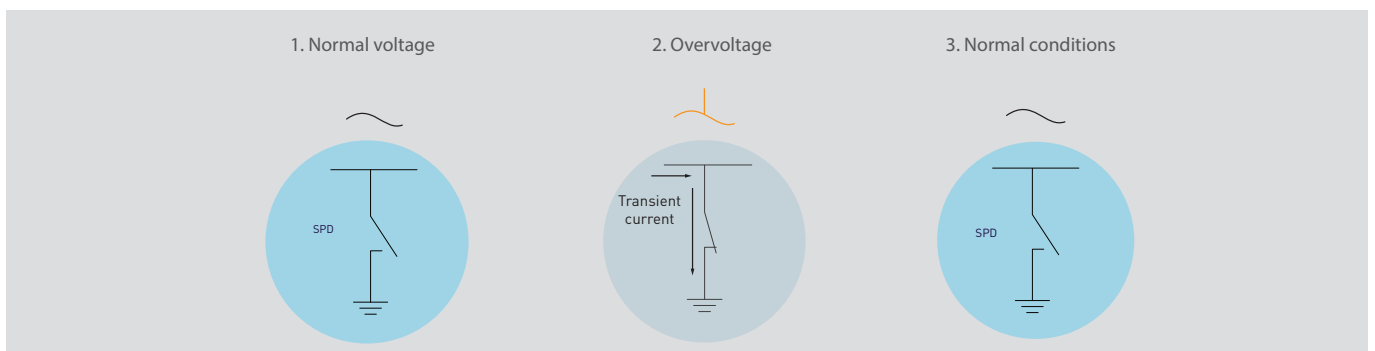

# The main technologies

Surge protective devices are mainly based on the use of 3 types of component.

## ■ Spark gaps:

Devices generally consisting of 2 electrodes placed face to face and between which a spark-over (followed by a subsequent current) occurs as soon as an overvoltage reaches a certain value at its terminals.

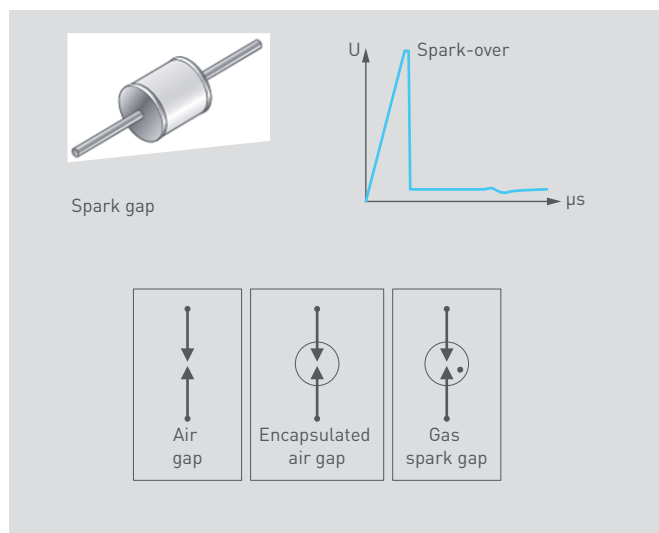

## ■ Varistors:

A varistor is a zinc oxide-based (ZnO) semiconductor component that has the property of being highly “non-linear”. That is to say, below a certain voltage ( $U_c$ ), the component is insulating (a few  $\mu A$  to a few mA of leaks). However, when the voltage at its terminals exceeds a certain threshold ( $U_c$ ), the component becomes a conductor. This change of state happens in a few nanoseconds. This clipping operation avoids the current immediately. After several lightning strikes with presence of voltage at its terminals over the long term (several years), the varistor ages and must be replaced.

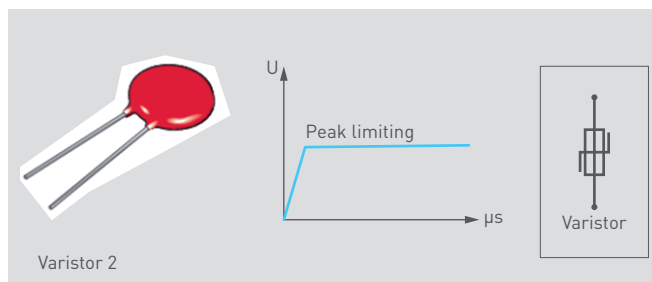

## ■ Silicon components (Zener diodes, thyristor, etc.):

A zener diode (voltage limiter) has a special structure to optimise its peak limiting behaviour. These components are used at very low voltage on Telecom/Internet lines or in electronics. Their response time is excellent, but their dissipation capacity is limited.

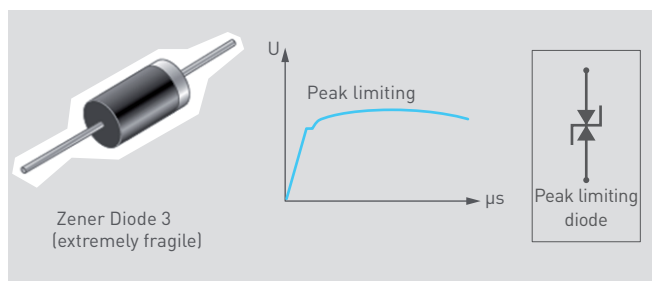

Surge protective devices for protecting the low voltage grid (230/400 V) use varistors and spark gaps.

## Surge protective device types

There are three types of surge protective devices called Type 1, Type 2 and Type 3.

The different types are linked to three characterisation methods in terms of flow capacity and dealing with overvoltages.

The surge protective device can be characterised by several types:

Type 1 + Type 2 or Type 2 + Type 3.

Types 1 and 2 have a flow capacity expressed in kA, but with a value that is not comparable:

$I_{imp}$  is the unit only applicable to Types 1.

$I_{max}$  and  $I_n$  are the units only applicable to Types 2.

Both types are related to the overvoltage waveforms used to assess flow capacity.

Type 1: "10/350" waveform, whose  $max = I_{imp}$  in kA.

Type 2: "8/20" waveform, whose  $max = I_{max}$  or  $I_n$ .

The 10/350 wave is much more energetic (surface of the curve) than the 8/20 wave. However, the "Max" peak is lower in the 10/350 wave than the 8/20 wave, which causes confusion.

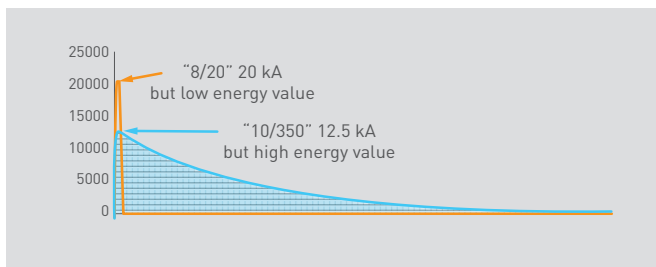

**!** Do not confuse the SPD lightning flow capacities expressed in kA with the short-circuit currents also expressed in kA.

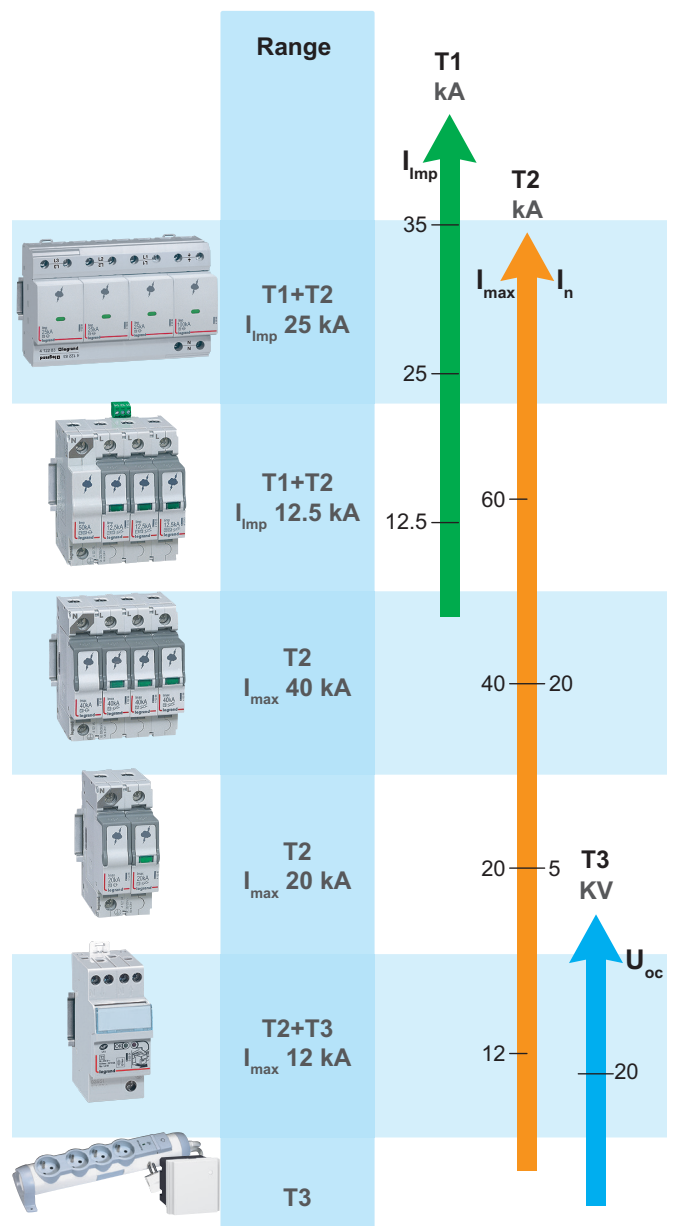

Non-linear illustrative representation of the 3 scales characterising surge protective devices

# Why is protection needed?

SPDs are an active product whose components age naturally over time.

For example, varistors under permanent mains voltage and during the “overvoltage treatment” phases have their insulation level reduced (current leaks of up to a few mA).

Thus, varistors will reach their end of life in two ways:

- Current leakage (in the range of 10 to 20 mA, which will be sufficient to activate the internal thermal protection). All varistor-based surge protective devices are equipped with such thermal protection.
- Short-circuit in the surge protective device → requires protection.

Potential short-circuit protection is often external (fuses or circuit breakers - see Legrand recommendation table on page 12) but can be integrated into the surge protective device, such as:

- SPD Type 2, Cat. No. 4 122 10/11/14/15

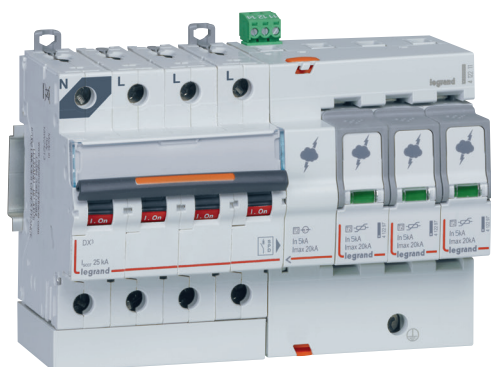

Cat.No 4 122 11

- SPD Type 2 + Type 3, Cat. Nos. 0 039 51/53/53/71/73

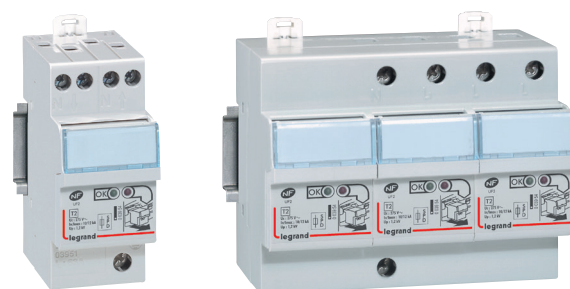

Cat.No 0 039 51

Cat.No 0 039 73

As for spark gaps, they are sized in such a way that they last much longer than varistors.

### ■ Associated protection or existing protection in the installation?

For short-circuited end-of-life, it is possible to limit use to the first protection already present in the installation (P1), which is upstream of the surge protective device connection point, provided that this protection does not exceed a recommended maximum (see page 12).

In this case, if a short-circuit occurs in the surge protective device, there will be a loss of operation in the installation.

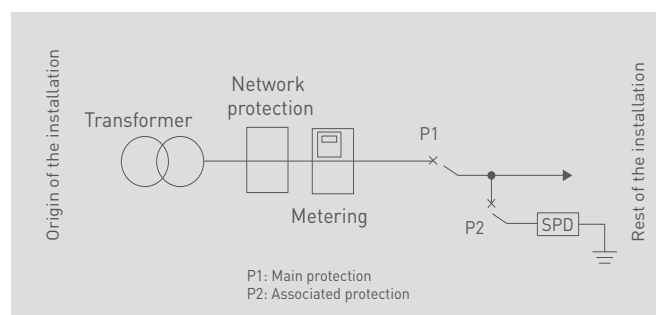















To avoid this, Legrand recommends dedicated protection against short-circuits on the lightning protection line (P2) and coordination between the 2 protections.

It is for this second case that short-circuit protection is required.

# UNDERSTANDING SURGE PROTECTIVE DEVICES

The table below allows you to choose the most suitable protection for your surge protective device (circuit breaker or fuse) and the cable cross-section for each case.

**Table of maximum protections for SPDs**

1	230/400 V~; 240/415 V~; 50/60 Hz				Ø: (X, Y, Z)
	TT		TN	IT	
	1P/2P/4P	1P+N/ 3P+N			
<b>T1+T2/ 35 kA</b>	 	DPX3 160 (80A) gG ≤ 400 A			16-25 mm <sup>2</sup>
<b>T1+T2/ 25 kA</b>	 	DPX3 160 (80A) gG ≤ 315 A			16-25 mm <sup>2</sup>
<b>T1+T2/ 12.5 kA</b>	 	C63 gG ≤ 125 A			≥ 16 mm <sup>2</sup>
<b>T1+T2/ 8 kA</b>	 	C40 gG ≤ 80 A			≥ 10 mm <sup>2</sup>
<b>T2/40 kA Uc=440 V</b>	 	C40 gG ≤ 63 A			≥ 10 mm <sup>2</sup>
<b>T2/40 kA Uc=320 V</b>	 	C40 gG ≤ 63 A			≥ 10 mm <sup>2</sup>
<b>T2/20 kA</b>	 	C20 gG ≤ 40 A			≥ 6 mm <sup>2</sup>

**Example of implementing a T2 I<sub>max</sub> 40 kA SPD Cat. No. 4 122 44:**

The associated nominal protection recommended for this SPD is a C40 circuit breaker or a gG 63 A fuse.

- If P1 is a C40 circuit breaker, then a P2 protection can be avoided.
- If P1 is a C125 circuit breaker, then a specific lightning protection P2 is mandatory and should be a C40.



Some installations require maximum service continuity including on the lightning protection branch, hence the need for P2 protection.

In this case, it is possible to use up to 2 ratings lower than recommended.

Example:

- For Type 1 + Type 2 surge protectors - I<sub>imp</sub> 12.5 kA - a 63 A C-curve circuit breaker is recommended. For selectivity purposes with upstream protection, a 50 A or even 40 A rating (two ratings lower than the recommended rating) may be used, but in this case, it is imperative to use one of the circuit breaker's auxiliary status contacts in order to monitor any untimely tripping of the latter in the event of a significant lightning shock.



Cat.No 4 122 74

# SPDs and earth leakage protection

## WHAT ABOUT STANDARDS?

Installation standards recommend the presence of residual current protection upstream of type CT1 and type CT2 surge protective devices with spark gap technology on the neutral that do not meet the requirements for withstand to fault voltages (TOV).

This protection must have a minimum lightning shock immunity of 3 kA, and should preferably be S Type. In France, in limited-power situations (residential and small commercial), this requirement is verified by the presence of the residual current circuit breaker with overload protection (RCBO) at the supply end of the installation provided by the energy supplier (often called the "500 mA"). As a result, surge protective devices can be installed upstream of the 30 mA RCDs in the switchboard.

## IS IT NECESSARY TO HAVE A DEDICATED RESIDUAL CURRENT PROTECTION ON THE SPD BRANCH?

There are two SPD architectures:

- CT1s (or  $x + 0$  or  $xP$ ) consist only of varistors, all connected to the Earth. However, we have seen that this component undergoes an ageing process, which may result in a slight current called "leakage". This very low current will be limited by thermal disconnection, but before reaching this level, these leaks to Earth can cause untimely tripping of the RCDs upstream in the installation. For this reason, with CT1 architectures, a "dedicated" residual current protection on the SPD branch may be recommended to ensure continuity of service.
- CT2 surge protective devices (1+1/3+1 or P+N/3P+N) offer combined varistors + spark gap technology. The varistors are, in this case, connected between phase and neutral and the spark gap is connected between neutral and Earth. Thus, the spark gap is used to isolate the varistors from Earth. As a result, the low current consumed by the varistors will be between phase and neutral like any other load without triggering the RCDs.

→ P+N and 3P+N SPD do not require dedicated residual current protection in the SPD branch to ensure continuity of service.

In addition to the advantage of not causing unintentional tripping of the residual current protections present upstream, CT2 surge protective devices also offer optimised protection against common mode and residual current overvoltages (only common mode with CT1).

## SOME SURGE PROTECTIVE DEVICES CAN BE INSTALLED UPSTREAM OF THE SUPPLY END RESIDUAL CURRENT PROTECTION

In the event of significant electrical stress, some surge protective devices do not require residual current protection upstream. They are necessarily CT2 type configuration SPDs with spark gap technology on the Neutral/Earth branch whose resistance to fault voltages is reinforced:

- All 1P+N and 3P+N surge protective devices in the series Cat. No. 4 122 XX can be used **without** residual current protection upstream.
- Surge protective devices Cat. Nos. 0 039 51/53/53/71/73 must be used **with** residual current protection upstream.

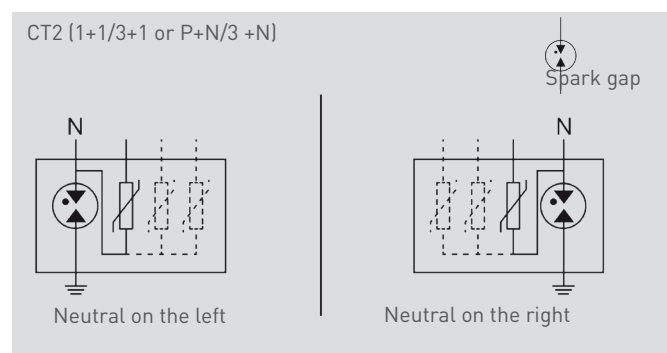
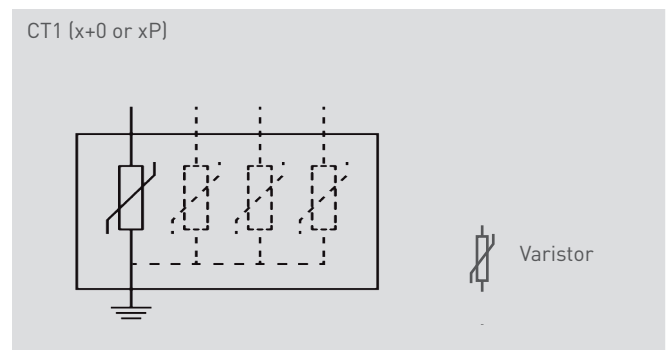

# HOW TO SELECT YOUR SURGE PROTECTIVE DEVICES

## UNDERSTANDING THE STANDARDS

### ■ Installation standard NF C 15-100 and UTE guide C 15-443

This is a summary of the criteria and mandatory situations to be taken into account when analysing the need for lightning protection without carrying out a risk analysis.

	AQ1 Zone	AQ2 Zone
<b>Lightning rod</b>	Mandatory min. T1 limp 12.5 kA	Mandatory min. T1 limp 12.5 kA
<b>Power line partly or fully overhead</b>	Recommended	Mandatory min. T2 In 5 kA
<b>Public buildings or medical care</b>	Recommended	Mandatory min. T2 In 5 kA
<b>The building is isolated</b>	Recommended	Recommended
<b>The building is equipped with expensive equipment</b>	Recommended	Recommended
<b>Maximum continuity of service required</b>	Recommended	Recommended

Depending on the exact keraunic level in each region, several "recommended" situations (example: overhead line + isolated building in AQ1 zone) can result in a mandatory situation.

If necessary, a risk analysis can be carried out (see guide UTE C 15-443) to determine precisely whether or not a surge protective device is mandatory. The use of surge protective devices in accordance with the recommendations in the selection chart (see following pages) ensures compliance with the installation standard.

### ■ International and European standards HD/IEC 60364-4-443

The latest versions (2015) make surge protective devices mandatory in installations:

- presenting risks for people (installations with security service, medical services, hospitals, etc.)
- for public service and heritage purposes (public service, communications centres, museums, places of worship, etc.)
- commercial and industrial (hotels, banks, industries, shops, farms, etc.)
- equipped with a Lightning Protection System (LPS, lightning rods) or designed according to EN/IEC 62305 standards
- hosting a large number of people such as residential buildings, offices, schools, etc. (additional requirement in Europe)

In the case of small installations (small businesses, private homes, etc.), a risk analysis must be carried out (article 443.5). If this is not done, the installation of surge protective devices is mandatory. However, a surge protective device is not mandatory in private homes if the cost of installing it is higher than the cost of installation divided by 5. The use of surge protective devices in accordance with the recommendations in the selection chart ensures compliance with the installation standard.



**i** In large installations, the maximum efficiency of overvoltage protection requires several surge protective devices, especially in the case where the surge protective device at the supply end has a  $U_p$  protection level higher than 1.5 kV (EN 62305 and TS 61643-12).

In general, it is advisable to use additional surge protective devices at the supply end of the installation when the equipment to be protected is more than 10 m away from the supply end surge protective device.

**In Offices-Industry:** this means the installation of a surge protective device in the distribution boards if they are more than 10 m away from the main low voltage switchboard, but also protections close to the equipment if it is more than 10 m away from the distribution board.

**In homes:** Installation of a proximity SPD (T3 type wall socket or multi-socket) if sensitive equipment is more than 10 m from the protection board.

The installation standard recommends that if there is a low voltage surge protective device on the power circuit, it is highly advisable to install a surge protective device on the communication line.



**SELECTION METHOD EXPLAINED**

To choose and select the appropriate surge protective device for each project, Legrand has developed a simple and effective selection method based on three categories: the geographical area, the type of project and a set of simple questions.

**1 GEOGRAPHICAL AREA**

Storm activity varies according to geographical situations and this has been transcribed into a map of lightning strikes densities (Ng or Nsg, see page 5) for the world and a map of keraunic levels for France (Nk). The capacities and endurance of the surge protective devices will be adapted to each level.

**2 SET OF QUESTIONS**

Then, just follow the question path: Yes/No/Don't know. The questions are sorted in descending order of constraints (frequency and amplitude of overvoltages). They result in surge protective devices of varying degrees of capacity. Answering Yes to one of the questions means it is no longer necessary to deal with the questions below because they are naturally covered by the level chosen (see an example page 18).

 **In some cases, there are two possible choices in terms of catalogue item: the first catalogue item includes short-circuit protection. This is the best choice (easy assembly).**

However, if the short-circuit current at the SPD installation point is > the I<sub>sc</sub> indicated in this reference table, you should choose the second catalogue item (SPD without I<sub>sc</sub> protection) and then select an associated protection from the table below.

 **SPECIAL CASE IF THERE IS AN EXTERNAL PROTECTION ON THE BUILDING (LIGHTNING ROD)**

In this case, it is not the level of thunderstorm activity that allows the final choice of appropriate surge protective device to be made, but the level of protection of this passive protection.

This level, governed by the IEC/EN 62305 standard, is essential output data determined during the study: It is either standard (Class III or IV), and in this case, a minimum T1 I<sub>imp</sub> 12.5 kA surge protective device is required, or high (Class I or II), and in this case, a minimum T1 I<sub>imp</sub> 25 kA surge protective device is required.

**3 TYPE OF BUILDING (SEE PAGE 19)**

The selection chart is limited to two types of building:

- Either a home/detached house/typical office < 50 m<sup>2</sup>
- Or a larger building, which in most cases will have at least two levels of protective cabinet: a main distribution board and a secondary distribution board.

In the case of small offices or multi-floor projects with a single protection board, please refer to the "main distribution board" column.

In the case of blocks of flats, the main switchboard recommendation should be applied to the main switchboard of the building and the secondary distribution board protection should be implemented in the protection cabinet of each dwelling, unless multi-floor protection exists.

In the latter case, each dwelling can also be protected with the SPD Cat. No. 0 039 51 or Cat. No. 0 039 71.

SPDs Cat.No	T1+T2 I <sub>imp</sub> 25 kA or 35 kA 4 122 80/81/82/83		T1+T2 I <sub>imp</sub> 12,5 kA 4 122 70/72/74/75			T2 I <sub>max</sub> 40 kA 4 122 30/32/ 33/40/42/44/45/64/65			T2 I <sub>max</sub> 20 kA 4 122 20/24/25/60/61		
Circuit breaker Cat.No	DPX <sup>3</sup> 160 (80 A)		DX <sup>3</sup> 63 A Curve C			DX <sup>3</sup> 40 A Curve C			DX <sup>3</sup> 20 A Curve C		
	3P	3P + N	2P	3P	3P + N	2P	3P	3P + N	2P	3P	3P + N
I <sub>cc</sub> ≤ 10 kA	-	-	4 077 90	4 078 35	4 079 04	4 077 88	4 078 33	4 079 02	4 077 85	4 078 30	4 078 99
I <sub>cc</sub> ≤ 16 kA	4 200 04	4 200 14	4 092 27	4 092 79	4 093 61	4 092 25	4 092 77	4 093 59	4 092 22	4 092 74	4 093 56
I <sub>cc</sub> ≤ 25 kA	4 200 44	4 200 54	4 097 74	4 097 87	4 098 00	4 097 72	4 097 85	4 097 98	4 097 69	4 097 82	4 097 95
I <sub>cc</sub> ≤ 36 kA	4 200 84	4 200 94	4 100 14	4 100 27	4 100 40	4 100 12	4 100 25	4 100 38	-	-	-
I <sub>cc</sub> ≤ 50 kA	4 201 24	4 201 34	4 101 54	4 101 67	4 101 80	4 101 52	4 101 65	4 101 78	-	-	-

SELECTION METHOD EXPLAINED (CONTINUED)

**STEP 1** LOCATE THE GEOGRAPHICAL AREA OF THE PROJECT

FRANCE: AQ1 AQ2

INTERNATIONAL: Nk ≤ 25 days per year or Ng (Measured) ≤ 1  
Nk > 25 days per year or Ng (Measured) > 1



**STEP 2** ANSWER THE SET OF QUESTIONS UNTIL YOU GET A "YES"

? → ✓ YES

If there is a lightning rod: you must know your level of protection (I/II/III/IV)



**ETAPE 3** SELECT THE TYPE OF BUILDING

Homes
 Offices - Industry - Collective housing

You must take account of the SPD installation level and the neutral earthing system



**LEGRAND RECOMMENDATION**

In some cases, there are two catalogue items: the first is to be preferred because it includes protection against short-circuits

**CHOOSE YOUR SPD IN FRANCE (THIS PAGE IS FOR INFORMATION ONLY, PLEASE CONSULT THE CATALOGUE PAGES FOR CATALOGUE NUMBERS AND POSSIBLE UPDATES)**

**STEP 1** SELECT YOUR AREA AQ1 OR AQ2

**AQ2** Nk > 25 days/year      **AQ1** Nk ≤ 25 days/year  
Nk: Keraunic level

■ Guadeloupe  
■ Guyana  
■ Martinique  
■ Mayotte  
■ Tahiti  
■ New Caledonia  
■ Reunion  
■ St Pierre & Miquelon

■ Example 1 for France

**STEP 1** GEOGRAPHICAL AREA OF THE PROJECT  
FRANCE: DETACHED HOUSE  
CALVADOS (14)

**AQ1**

**STEP 2** SET OF QUESTIONS UNTIL A "YES" IS OBTAINED

LIGHTNING ROD ? → NO

OVERHEAD LINE ? → YES

**STEP 3** SELECT THE TYPE OF BUILDING

HOMES

Housing installation level and neutral earthing system: 1P + N

**LEGRAND RECOMMENDATION**

0 039 51

**STEP 2** ANSWER THE QUESTIONS ?

	<ul style="list-style-type: none"> <li>Is there a lightning protection system on the building (lightning conductor, etc) or less than 50 m away?</li> </ul> <p>4 possible levels (Protection Level), determined by the Design office in accordance with IEC 62305</p>	<p>YES</p>
	NO	
	<ul style="list-style-type: none"> <li>Is the power line partly or fully overhead (final 2 km)?</li> </ul>	<p>YES or "I don't know"</p>
	NO	
	<ul style="list-style-type: none"> <li>Does the building open to the public or provide medical care (museums, town halls, retirement homes, hotels, banks, shops, etc)?</li> <li>Is the building isolated or in a mountainous area?</li> </ul>	<p>YES or "I don't know"</p>
	NO	
	<ul style="list-style-type: none"> <li>Does the building contain expensive equipment?</li> <li>Is maximum continuity of service required?</li> </ul>	<p>YES or "I don't know"</p>
	I DON'T HAVE ANY INFORMATION	

Example 2:  
A mansion in the Loire Valley (AQ1) is equipped with a lightning rod. A Type 1 surge protective device is mandatory and will be for Level III/IV lightning rods, which are the most common. The most suitable SPD will then be Cat. No. 4 122 74 if the house has a single-phase supply, or Cat. No. 4 122 75 if the house has a three-phase supply.

What is the Protection Level for the external lightning protection system (all keraunic levels)?							
Protection Level III and IV or 'Don't know'				Protection Level I and II			
Number of poles	Private homes	Commercial - Industrial - Apartment bldgs		Number of poles	Private homes	Commercial - Industrial - Apartment bldgs	
		Main LV distrib. board	Secondary distribution board or flat			Main LV distrib. board	Secondary distribution board or flat
	T1+T2 I <sub>imp</sub> 12.5 kA	T1+T2 I <sub>imp</sub> 12.5 kA	T2 I <sub>max</sub> 20 kA		T1+T2 I <sub>imp</sub> 25 kA	T1+T2 I <sub>imp</sub> 25 kA	T2 I <sub>max</sub> 40 kA
1P	4 122 70	4 122 70	4 122 20	1P	-	4 122 80	4 122 40
1P+N	4 122 74	2 4 122 74	4 122 10 <sup>(1)</sup> (Isc ≤ 25 kA) 4 122 24	1P+N	-	4 122 81	4 122 14 <sup>(1)</sup> (Isc ≤ 25 kA) 4 122 44
3P	4 122 72	4 122 72	-	3P	-	4 122 82	4 122 42
3P+N	4 122 75	2 4 122 75	4 122 11 <sup>(1)</sup> (Isc ≤ 25 kA) 4 122 25	3P+N	-	4 122 83	4 122 15 <sup>(1)</sup> (Isc ≤ 25 kA) 4 122 45

AQ1				AQ2			
	T2+T3 I <sub>max</sub> 12 kA	T1+T2 I <sub>imp</sub> 12.5 kA	T2 I <sub>max</sub> 20 kA		T2+T3 I <sub>max</sub> 12 kA	T1+T2 I <sub>imp</sub> 12.5 kA	T2 I <sub>max</sub> 20 kA
1P	-	4 122 70	4 122 20	1P	-	4 122 70	4 122 20
1P+N	1 0 039 51 <sup>(1)</sup> (Isc = 4.5 kA)	4 122 74	4 122 10 <sup>(1)</sup> (Isc ≤ 25 kA) 4 122 24	1P+N	0 039 51 <sup>(1)</sup> (Isc = 4.5 kA)	4 122 74	4 122 10 <sup>(1)</sup> (Isc ≤ 25 kA) 4 122 24
3P	-	4 122 72	-	3P	-	4 122 72	-
3P+N	0 039 53 <sup>(1)</sup> (Isc = 4.5 kA)	4 122 75	4 122 11 <sup>(1)</sup> (Isc ≤ 25 kA) 4 122 25	3P+N	0 039 53 <sup>(1)</sup> (Isc = 4.5 kA)	4 122 75	4 122 11 <sup>(1)</sup> (Isc ≤ 25 kA) 4 122 25

	T2+T3 I <sub>max</sub> 12 kA	T2 I <sub>max</sub> 40 kA	T2+T3 I <sub>max</sub> 12 kA		T2+T3 I <sub>max</sub> 12 kA	T1+T2 I <sub>imp</sub> 12.5 kA	T2 I <sub>max</sub> 20 kA
1P	-	4 122 40	-	1P	-	4 122 70	4 122 20
1P+N	0 039 51 <sup>(3)</sup> (Isc = 4.5 kA)	4 122 14 <sup>(1)</sup> (Isc ≤ 25 kA) 4 122 44	0 039 71 <sup>(1)</sup> (Isc 10 kA) <sup>(2)</sup>	1P+N	0 039 51 <sup>(1)</sup> (Isc = 4.5 kA)	4 122 74	4 122 10 <sup>(1)</sup> (Isc ≤ 25 kA) 4 122 24
3P	-	-	-	3P	-	4 122 72	-
3P+N	0 039 53 <sup>(3)</sup> (Isc = 4.5 kA)	4 122 15 <sup>(1)</sup> (Isc ≤ 25 kA) 4 122 45	0 039 73 <sup>(1)</sup> (Isc 10 kA) <sup>(2)</sup>	3P+N	0 039 53 <sup>(1)</sup> (Isc = 4.5 kA)	4 122 75	4 122 11 <sup>(1)</sup> (Isc ≤ 25 kA) 4 122 25

	T2+T3 I <sub>max</sub> 12 kA	T2 I <sub>max</sub> 20 kA	T2+T3 I <sub>max</sub> 12 kA		T2+T3 I <sub>max</sub> 12 kA	T2 I <sub>max</sub> 40 kA	T2+T3 I <sub>max</sub> 12 kA
1P	-	4 122 20	-	1P	-	4 122 40	-
1P+N	0 039 51 <sup>(3)</sup> (Isc = 4.5 kA)	4 122 10 <sup>(1)</sup> (Isc ≤ 25 kA) 4 122 24	0 039 71 <sup>(2)</sup> (Isc 10 kA)	1P+N	0 039 51 <sup>(1)</sup> (Isc = 4.5 kA)	4 122 14 <sup>(1)</sup> (Isc ≤ 25 kA) 4 122 44	0 039 71 <sup>(2)</sup> (Isc 10 kA)
3P	-	-	-	3P	-	-	-
3P+N	0 039 53 <sup>(3)</sup> (Isc = 4.5 kA)	4 122 11 <sup>(1)</sup> (Isc ≤ 25 kA) 4 122 25	0 039 73 <sup>(1)</sup> (Isc 10 kA) <sup>(2)</sup>	3P+N	0 039 53 <sup>(1)</sup> (Isc = 4.5 kA)	3 4 122 15 <sup>(1)</sup> (Isc ≤ 25 kA) 4 122 45	3 0 039 73 <sup>(1)</sup> (Isc 10 kA)

	T2+T3 I <sub>max</sub> 12 kA	T1+T2 I <sub>imp</sub> 12.5 kA	T2 I <sub>max</sub> 20 kA		T2+T3 I <sub>max</sub> 12 kA	T1+T2 I <sub>imp</sub> 12.5 kA	T2 I <sub>max</sub> 20 kA
1P	-	4 122 70	4 122 20	1P	-	4 122 70	4 122 20
1P+N	0 039 51 <sup>(3)</sup> (Isc = 4.5 kA)	4 122 74	4 122 10 <sup>(1)</sup> (Isc ≤ 25 kA) 4 122 24	1P+N	0 039 51 <sup>(1)</sup> (Isc = 4.5 kA)	4 122 74	4 122 10 <sup>(1)</sup> (Isc ≤ 25 kA) 4 122 24
3P	-	4 122 72	-	3P	-	4 122 72	-
3P+N	0 039 53 <sup>(3)</sup> (Isc = 4.5 kA)	4 122 75	4 122 11 <sup>(1)</sup> (Isc ≤ 25 kA) 4 122 25	3P+N	0 039 53 <sup>(1)</sup> (Isc = 4.5 kA)	4 122 75	4 122 11 <sup>(1)</sup> (Isc ≤ 25 kA) 4 122 25

Example 3:

A large shopping centre in an urban area located in Roanne (AQ2) equipped with a low-voltage main switchboard and secondary distribution boards. The short-circuit current at the main switchboard is 24 kA. There is no lightning rod, and underground power supply. The situation is not mandatory, but highly recommended.

The SPD catalogue number for the main switchboard: Cat.No 4 122 15

The SPD catalogue number for the distribution board: Cat.No 0 039 73

If remote feedback of the SPD status is desired in the secondary distribution board, use the next highest capacity equipped with a remote feedback Cat. No. 4 122 11.

Catalogue numbers with "(Iscxx kA)" incorporate short-circuit protection (they do not need external protection to be added)

1: If Isc > 25 kA, use the SPD with the recommended catalogue number without built-in Isc protection, and choose an external associated protection device with a suitable Isc capacity

2: If Isc > 10 kA, select a T2 I<sub>max</sub> 20 kA SPD

3: If Isc > 6 kA, select a similar SPD, but with Isc 10 kA (0 039 5x to 0 039 7x)

# HOW TO INSTALL YOUR SURGE PROTECTIVE DEVICES

The effectiveness of lightning protection depends on:

- the chosen surge protective device
- the quality of installation of the surge protective devices.

The most important rule to follow when installing an SPD is to check that the length is as short as possible between the connection point to the power network (Phase and Neutral) and the earthing system.

Thus, on this surge protective device branch, the standards mention the “50 cm rule”.

To illustrate this, we can present two installation scenarios:

- Plastic cabinets: the dimensions of the enclosure and the cable cross-sections used are limited.
- Metal cabinets: the cabinet dimensions and the cross-sections can be very large.



The 50 cm rule is easier to satisfy with surge protective devices that incorporate short-circuit protection.

## ■ Example with integrated Isc

$$X+Y+Z \leq 0.50 \text{ cm}$$

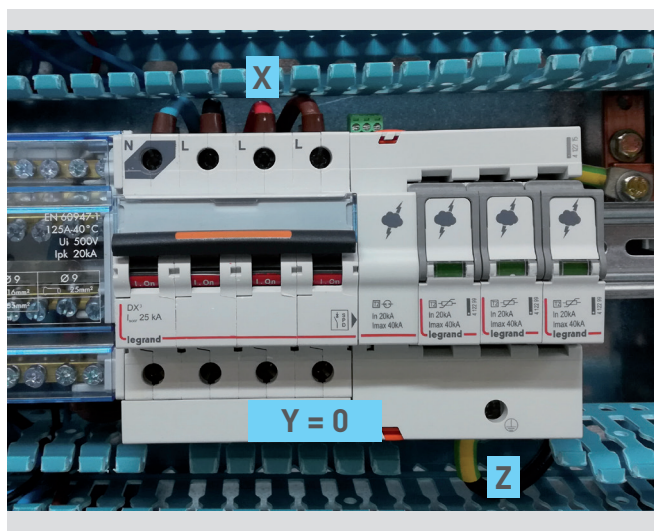

## ■ Example with external Isc

$$X+Y+Z \leq 0.50 \text{ cm}$$

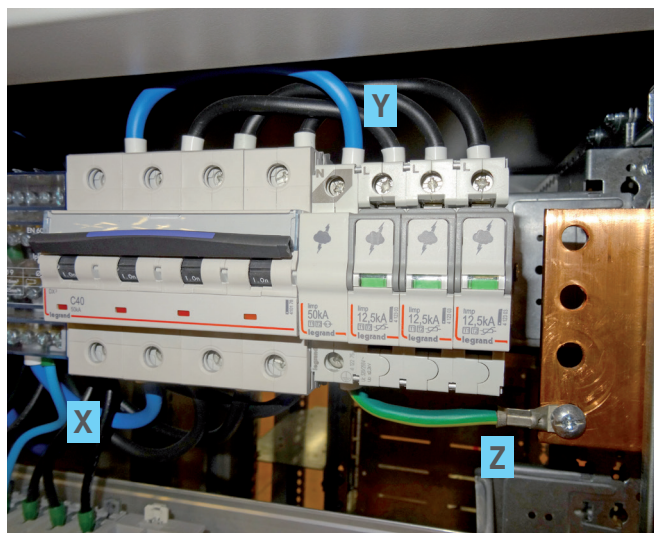

### IN A PLASTIC CABINET

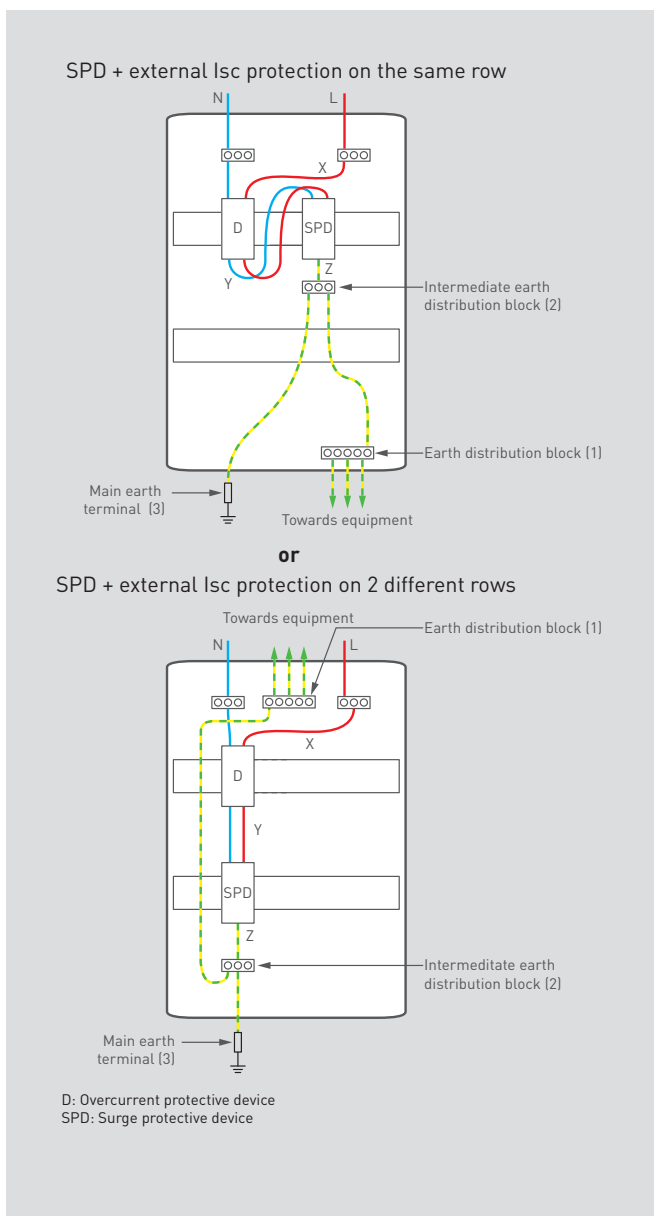

It is sufficient to install an “intermediate” (2) earth terminal block between the earth terminal block (1) which collects all the Earths from the equipment and various lines, and the main Earth terminal (3). The main earth terminal passes through this “intermediate” earthing terminal block near the surge protective device, and not through the main earthing terminal of the cabinet. Section Z is then as short as possible.



**When maintaining the surge protective device, continuity of the main protective conductor must be guaranteed.**

# HOW TO INSTALL YOUR SURGE PROTECTIVE DEVICE

## IN A METAL CABINET

### ■ Small size

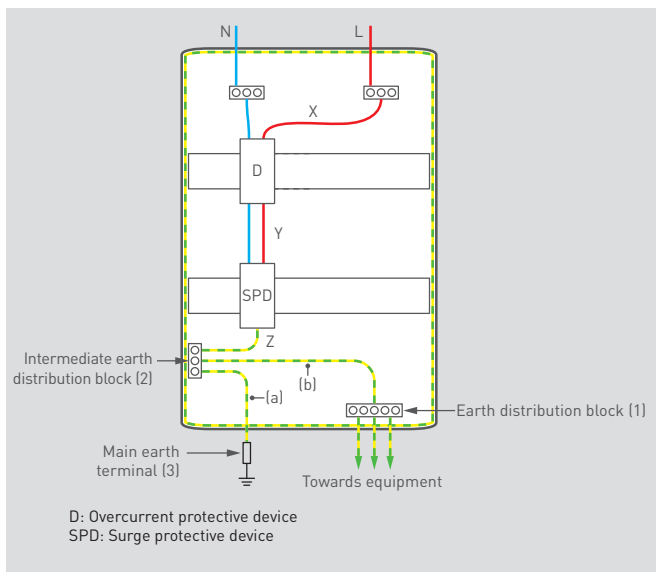

In the same way as plastic cabinets, it is possible to use an “intermediate” (2) earthing terminal block.



**Cross-section connection (b) = cross-section (a)**

### ■ Large size (Main LV distribution board or secondary distribution boards)

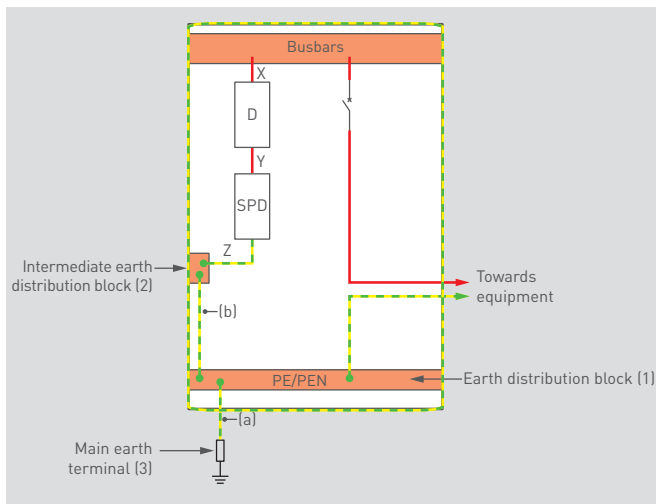

In this configuration, the main earth cable has too large a cross-section to be connected to the intermediate earth distribution block. The principle is to electrically connect this intermediate earth distribution block to the metal casing. Thus, between this intermediate earth distribution block and the main earth distribution block (1), the lightning current resulting from the overvoltage being dealt with by the surge protective device will be carried by the metal casing, which generates a negligible overvoltage across its surface. However, a green-yellow cable with the same cross-section as section Z must be used between this intermediate earth distribution block and the main earth distribution block.

However, a green-yellow cable (b), ensuring the short-circuit potential within the surge protective device at the end of its life, with a cross-section  $\geq$  to the cable (Z), must be installed between this intermediate earth distribution block (2) and the main earth distribution block (3).



### IMPACT OF THE LENGTH OF THE WIRES

During a lightning strike, a “limited” overvoltage remains (see actual protective voltage on page 24) and can propagate on the line, after the upstream lightning protection, towards the receivers.

The very high frequency (in GHz) of this residual overvoltage can cause voltage resonance phenomena, and when the length of the line exceeds 10 metres, the voltage can double. There is then a significant risk that this overvoltage could destroy the receivers.

Establishing good lightning protection must always take into account the length of the lines supplying the receivers to be protected. Indeed, beyond a certain length, the voltage applied to the receiver can, due to the resonance phenomenon, greatly exceed the expected limiting voltage. The resonance risk is related to the characteristics of the installation (conductors, bonding systems) and the increase in potential overvoltage is related to the value of the impulse current.

### CASCADED PROTECTION

A single surge protective device cannot always dissipate all the energy carried by the overvoltage. As the voltage residue reaching the equipment must not affect its operation, one or two additional SPDs should be added to the installation as close as possible to the point of use.

This is called cascading protection.

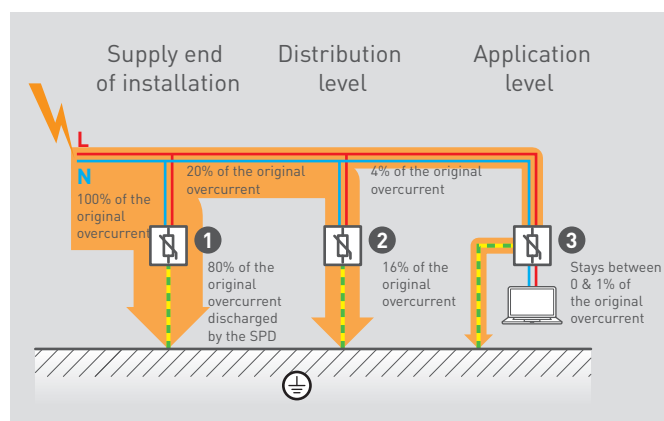

In order to limit overvoltages as much as possible, an SPD should be installed near the equipment to be protected (3).

However, this protection only protects the equipment directly connected to it, but above all, its low energy capacity does not allow all the energy to run off. For this reason, a lightning arrester is required at the head of the installation (1).

Conversely, the SPD (1) cannot protect the entire installation because it allows a quantity of residual energy to pass through and because lightning is a high-frequency phenomenon. Depending on the scope of the installation and the nature of the risks (exposure and sensitivity of the equipment, criticality of continuity of service), circuit protection (2) is required in addition to (1) and (3).



Cat.No 4 122 82



Cat.No 4 122 74



Cat.No 0 039 51

# SPD actual voltage protection level

Overtages of atmospheric origin can reach the equipment in 2 ways:

- Via the power network ①
- Via the earth connection ②

The main role of the SPD is to limit these overvoltages to an “acceptable overvoltage”. This maximum voltage, deemed “acceptable” by the equipment, is called the protective voltage, and the effective protective voltage after the SPD is installed, between the connection point to the power network (A) and the Earth (B), is made up of several voltages:

**■ Ur cables:**

The cables behave as a resistive and inductive element and will therefore generate a voltage at their terminals when the kA of the lightning strike passes through them.

For this reason, it is advisable to use cables with a minimum cross-section, preferably multistranded, and of the shortest possible length (50 cm rule).

**■ SPD Ur protection:**

The protection (fuse/circuit breaker) of the SPD will also generate a voltage at its terminals when the lightning strikes.

**■ SPD Up:**

The Up voltage is an important characteristic of the SPD, indicated on the product, or in the associated documents.

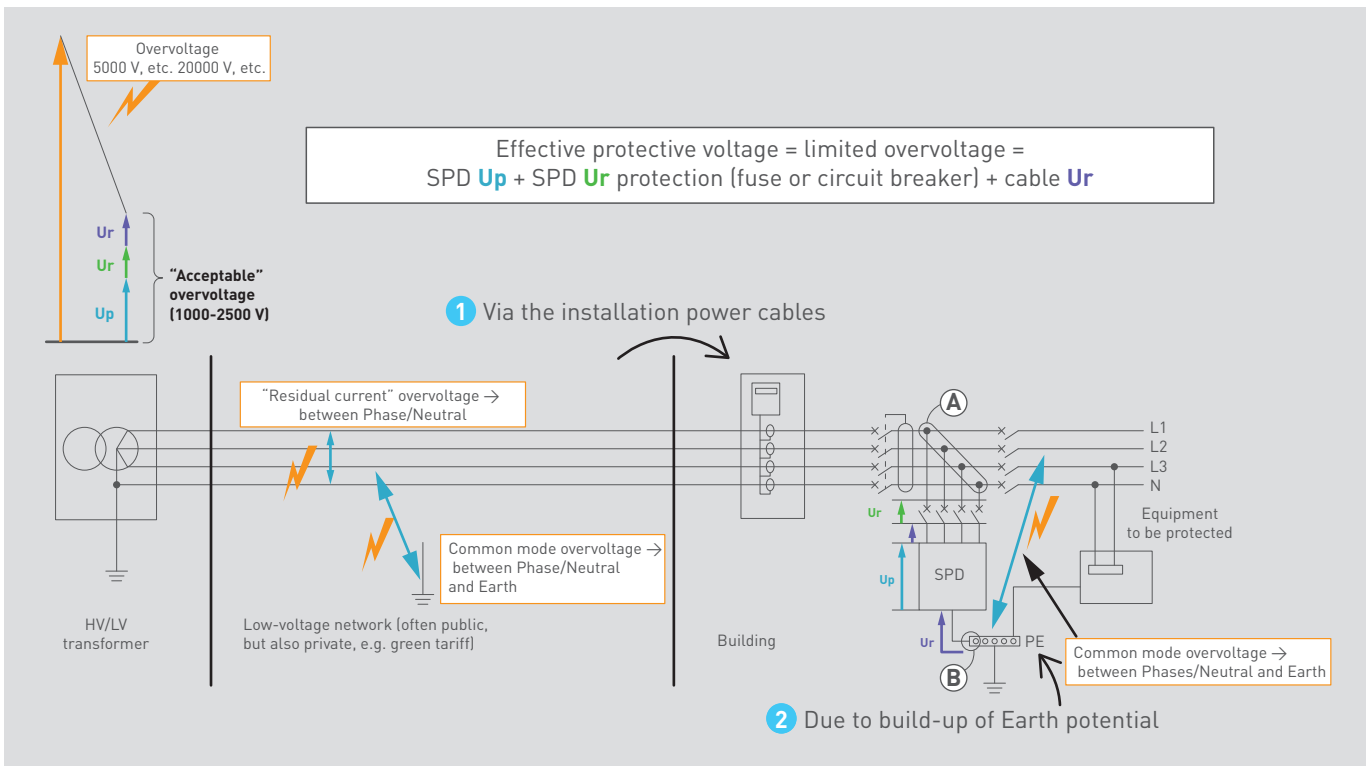

**i** The principle of cascaded protection is also used for extra low voltage applications (telephony, communication and data networks), combining the first two levels of protection in a single device that is usually located at the supply end of the installation.

## DEFINITIONS

### ■ Common mode:

this is the treatment or characteristics of overvoltages between active conductors (phase/neutral) and the earth network.

### ■ Differential mode

treatment or characteristics of overvoltages between active conductors (Phase/neutral - phase/phase)

### ■ I<sub>fi</sub>:

leakage current, short-circuit current that can be drained by a surge protective device consisting of an air spark gap once it has been initiated

### ■ I<sub>imp</sub>:

impulse current for class I test, peak wave current value 10/350

### ■ I<sub>max</sub>:

maximum discharge current, peak value of the wave current 8/20 during a class II shock

### ■ I<sub>n</sub>:

nominal discharge current, peak value of the admissible current in repeated 8/20 wave

### ■ Lightning rod/conductor:

allows lightning to be captured and buildings to be protected against direct impacts by draining energy to Earth. The standards use the term lightning protection system (LPS) because the solution can also be a cable mesh system or other system.

### ■ N<sub>G</sub> or N<sub>sG</sub>:

lightning density, number of lightning strikes per km<sup>2</sup> and per year

### ■ N<sub>k</sub>:

keraunic level, number of days per year for a given place where thunder is heard

### ■ Presumed I<sub>sc</sub>:

conditional short-circuit current at the installation point

### ■ Spark gap:

electrical component which can limit overvoltages at its terminals

### ■ SPD:

(surge protection device) international terminology for the name

### ■ Surge protective device:

device to provide protection against induced lightning overvoltages.

### ■ TOV:

Temporary overvoltage (more or less long) of the electrical installation due to a fault on the high or low voltage.

### ■ TVSS:

(transient voltage surge suppressors) American terminology for surge protective device

### ■ U<sub>c</sub> voltage:

must be higher than the voltage of the network to be protected. In the case of IT earthing systems, a U<sub>c</sub> > 400 V is required to take account of cases of double faults.

### ■ U<sub>n</sub>:

nominal alternating supply voltage

### ■ U<sub>oc</sub>:

maximum combined wave voltage acceptable for a type 3 SPD

### ■ U<sub>p</sub>:

effective protective voltage of the SPD

### ■ U<sub>t</sub>:

maximum temporary overvoltage admissible for a short time that the SPD can withstand

### ■ Voltage-dependent resistor:

electrical component consisting of metal oxides that should become conductive under the effect of a threshold voltage



For more information,  
please visit  
[export.legrand.com](http://export.legrand.com)



Other specifications and guides, as well as all the technical information for the products referenced can be found on: [www.export.legrand.com/en](http://www.export.legrand.com/en)

Click on **>DOCUMENTATION & SOFTWARE**

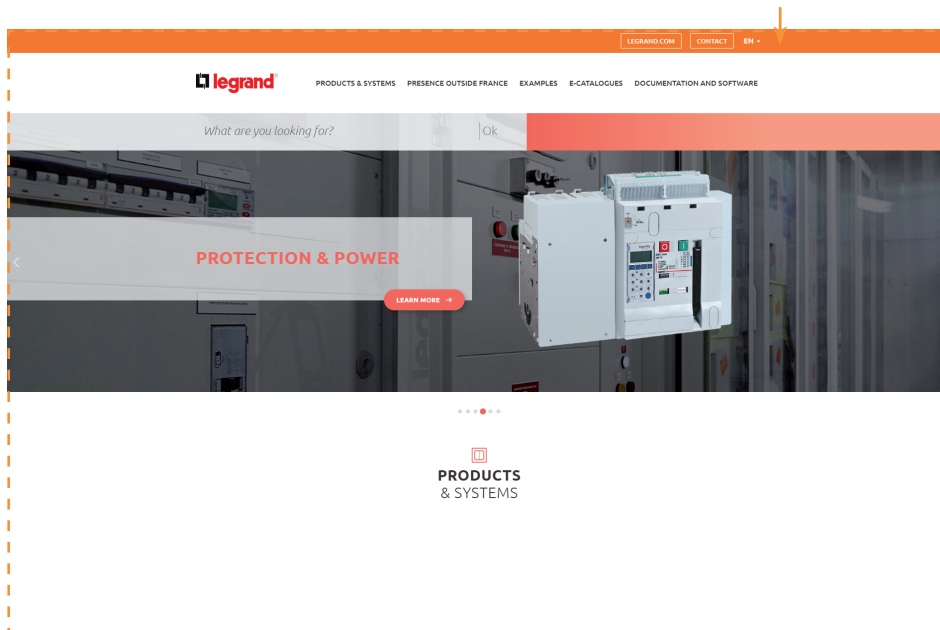

## >DOCUMENTATION

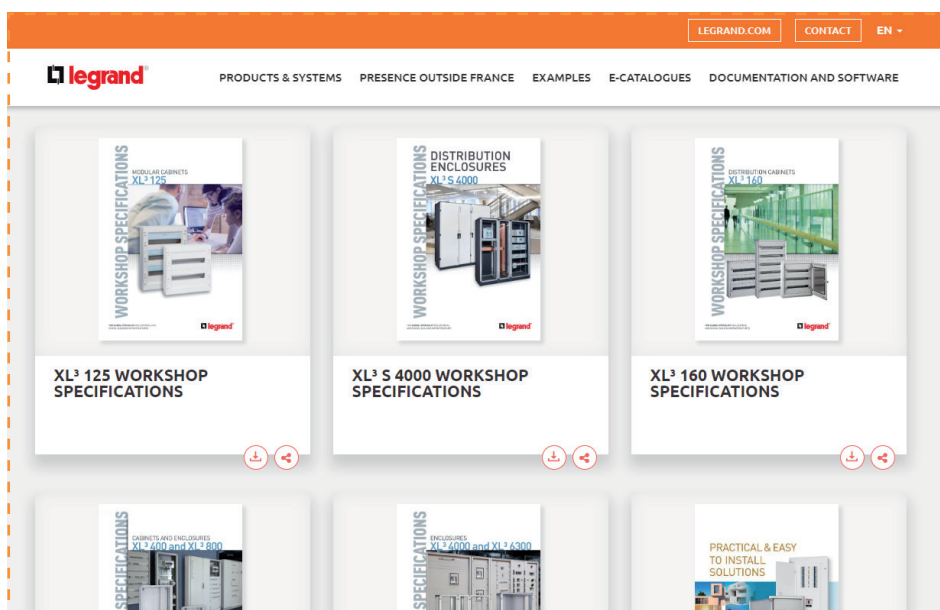



## FOLLOW US ON

@ [www.legrand.com](http://www.legrand.com)

 [youtube.com/user/legrand](https://youtube.com/user/legrand)

 [twitter.com/legrand\\_news](https://twitter.com/legrand_news)

 [pinterest.com/legrandgroup](https://pinterest.com/legrandgroup)



**Head office**  
and International Department  
87045 Limoges Cedex - France  
Tel: +33(0)5 55 06 87 87  
Fax: +33(0)5 55 06 74 55